

# BRIZO®

## LAVATORY FAUCET

- Tresa® Collection
- Single Handle Deck Mount

**STANDARD SPECIFICATIONS:**

- Max flow rate: 1.50 GPM @ 60 PSI, 5.68 L/Min @ 414 kPa
- Max flow rate (ECO models only): 1.20 GPM @ 60 PSI, 4.54 L/Min @ 414 kPa
- One hole mounting
- Ceramic cartridge
- Solid brass fabricated body
- Drain sold separately

**WARRANTY:**

- Lifetime limited warranty on parts (other than electronic parts and batteries) and finishes: or, for commercial users, for 5 years from date of purchase.
- 5 year limited warranty on electronic parts (other than batteries); or, for commercial users, for 1 year from the date of purchase. No warranty is provided on batteries.





**COMPLIES WITH:**

- ASME A112.18.1 / CSA B125.1
- ASME A112.18.2 / CSA B125.2
- ♿ Indicates compliance to ICC/ANSI A117.1
- EPA WaterSense®
- Verified compliant with 0.25% weighted average Pb content regulations

Submitted Model No.: \_\_\_\_\_

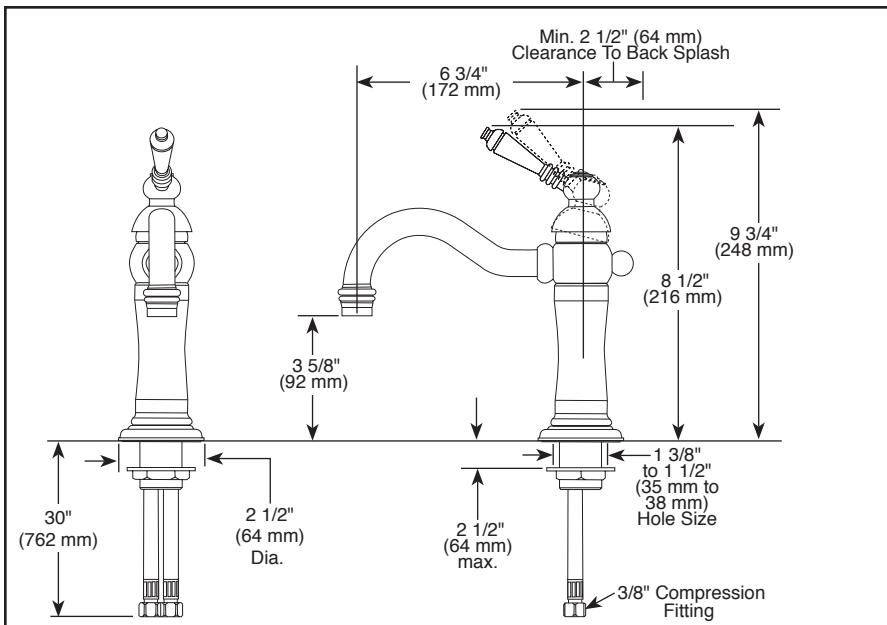
Specific Features: \_\_\_\_\_

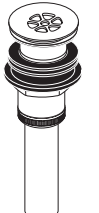

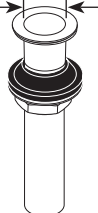
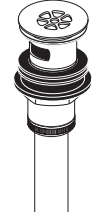
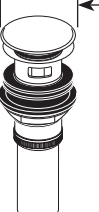
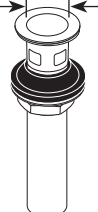
<p><b>RP72411▲</b> Grid Strainer Drain less overflow holes</p> 	<p><b>RP72413▲</b> Push Button Drain less overflow holes</p> <p>2 3/4" (70 mm) Dia.</p> 	<p><b>RP81627▲</b> Push Button Drain less overflow holes</p> <p>1 5/8" (41 mm) Dia.</p> 
<p><b>RP72412▲</b> Grid Strainer Drain with overflow holes</p> 	<p><b>RP72414▲</b> Push Button Drain with overflow holes</p> <p>2 3/4" (70 mm) Dia.</p> 	<p><b>RP81628▲</b> Push Button Drain with overflow holes</p> <p>1 5/8" (41 mm) Dia.</p> 

▲ Designate proper finish suffix