



California Faucets®

Belmont™

SINGLE HOLE LAV / VESSEL / BAR FAUCET

3501-2

Features

- Available in 28 finishes including 13 PVD finishes
- All brass construction
- 4-9/16" spout center to center
- Single handle operation cartridge with ceramic disc
- Flexible braided hoses for ease of installation
- Flush mount aerator insert
- 1.2 gpm (4.5 L/min) max flow rate

Codes/Standards Applicable

Product meets or exceeds the following:

- ASME A112.18.1/CSA B125.1
- NSF/ANSI 61 & NSF/ANSI 372
- CEC / DOE
- Commonwealth of MA
- EPA WaterSense High Efficiency Lavatory
- ADA compliant

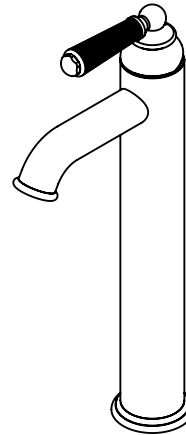

3501-2-HXX
(XX = Optional Series Handle)

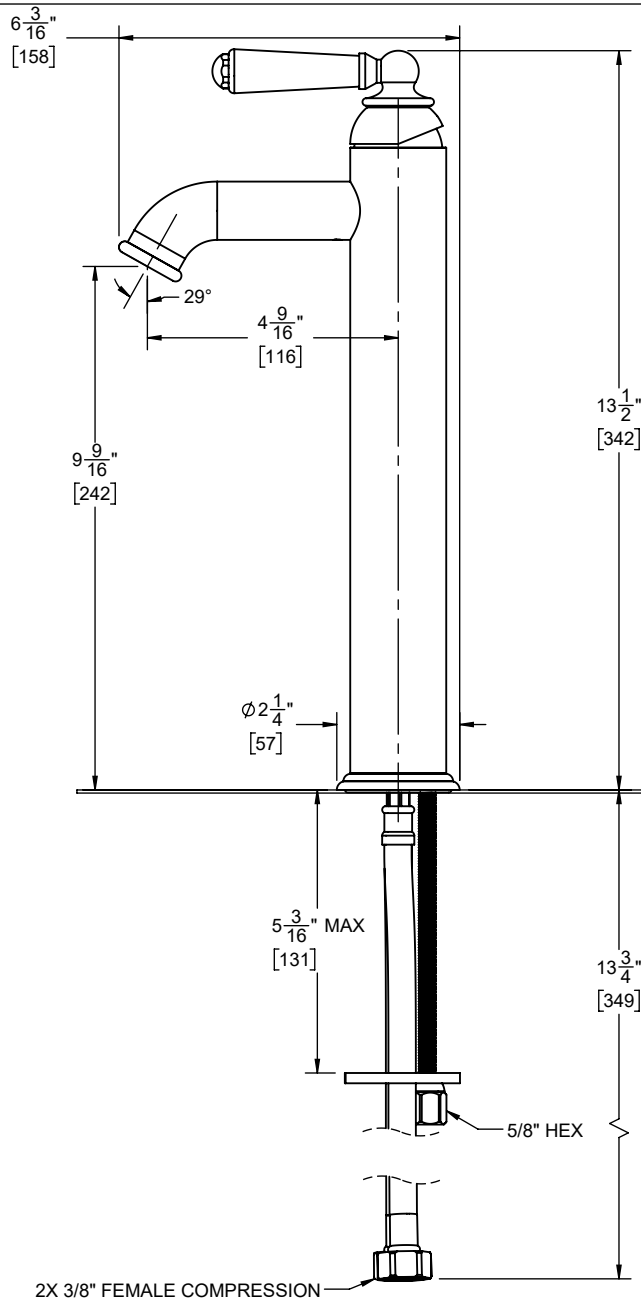

THROUGH-HOLE SPECIFICATIONS	
MIN	RECOMMENDED
SPOUT: \varnothing 1-1/4"	\varnothing 1-3/8"

DIMENSIONS SHOWN TO NEAREST 1/16"
[DIMENSIONS SHOWN TO NEAREST 1mm]



3501-2-H33

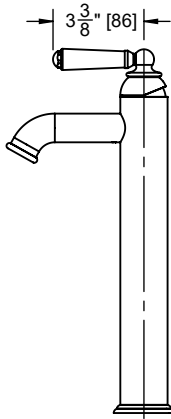
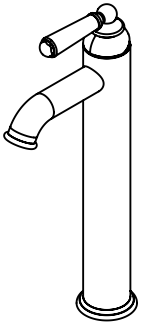

3501-2-H40

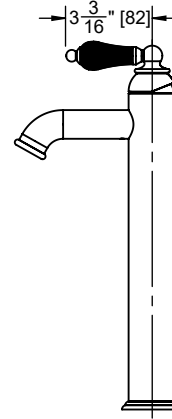
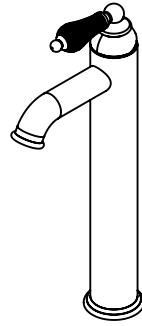

3501-2-H42

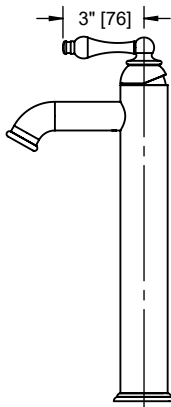
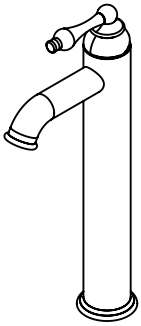

3501-2-H55

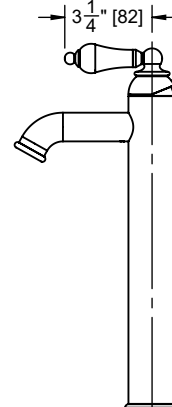
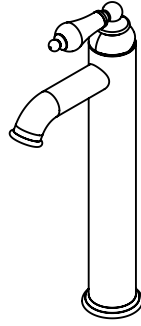

3501-2-H64

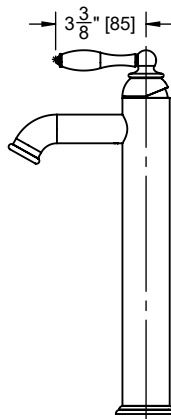
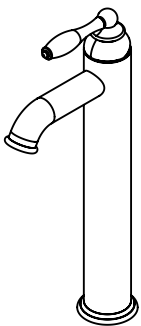

3501-2-H68

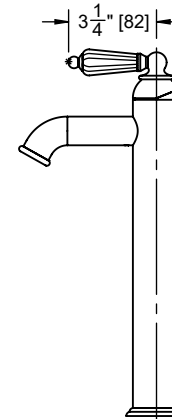
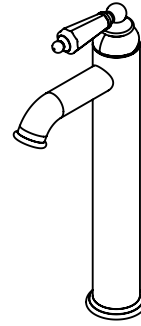

3501-2-CLEV

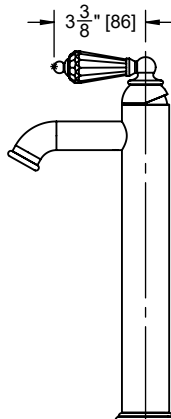
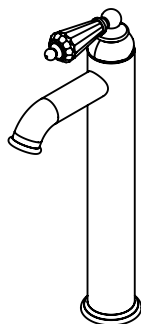

DIMENSIONS SHOWN TO NEAREST 1/16"
[DIMENSIONS SHOWN TO NEAREST 1mm]