

36-HSHK4

Wall Mounted Hand Shower Set

Flow Rate: 2.0 GPM

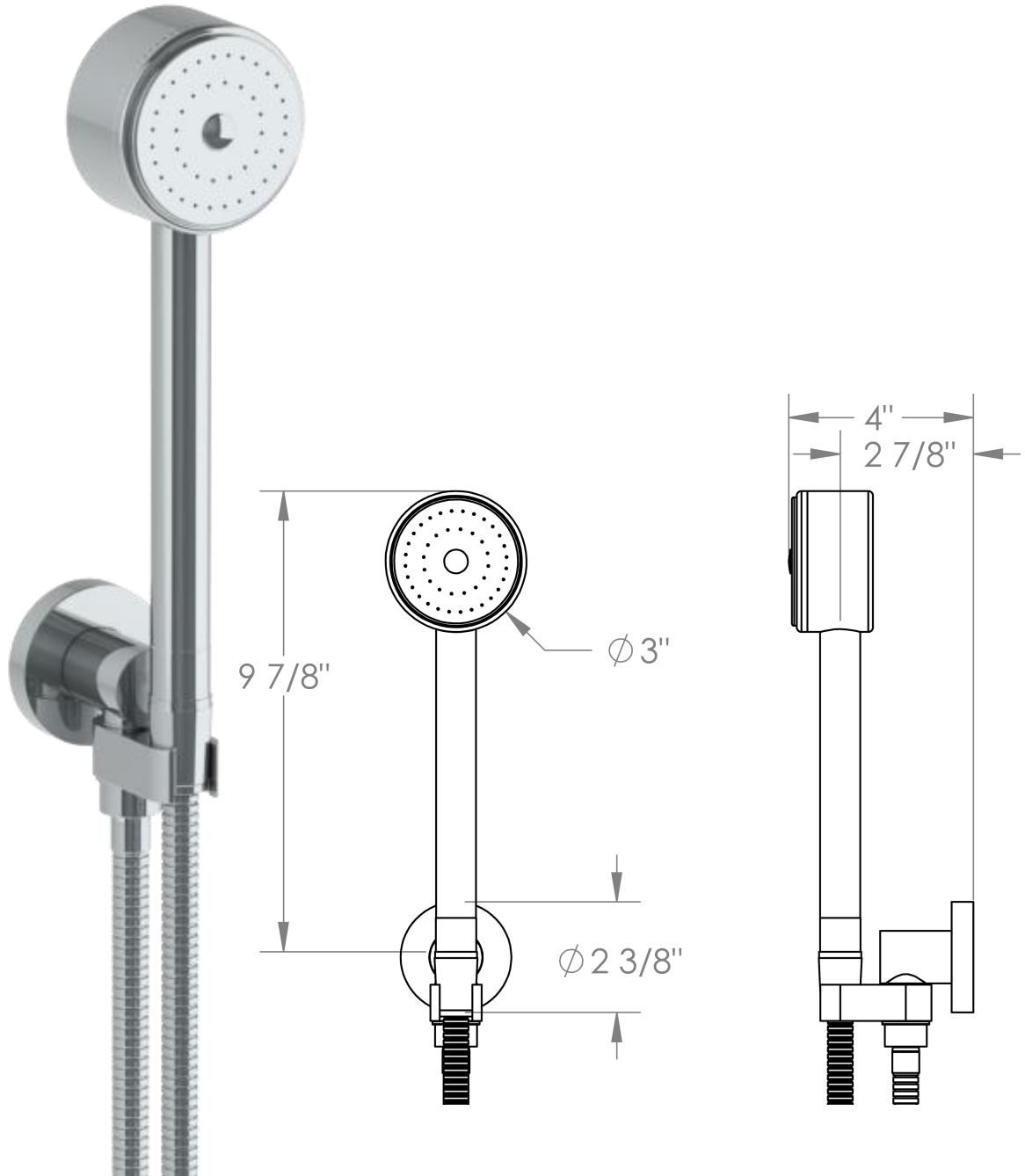

Meets the applicable requirements of ASME A112.18.1-2005/CSA B125.1-05, entitled "Plumbing Supply Fittings"