

70-0.5

Wall Mounted Robe Hook

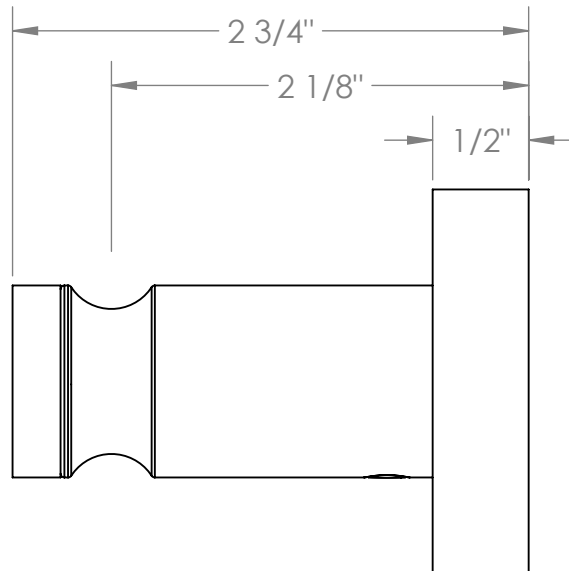
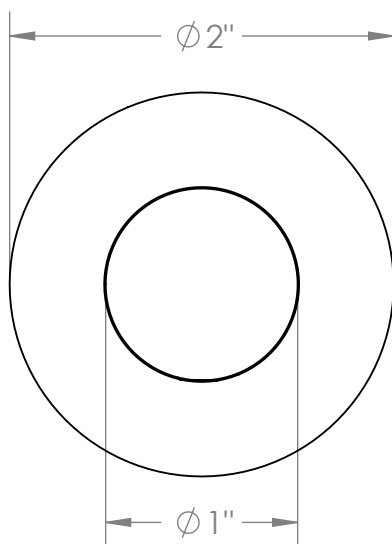
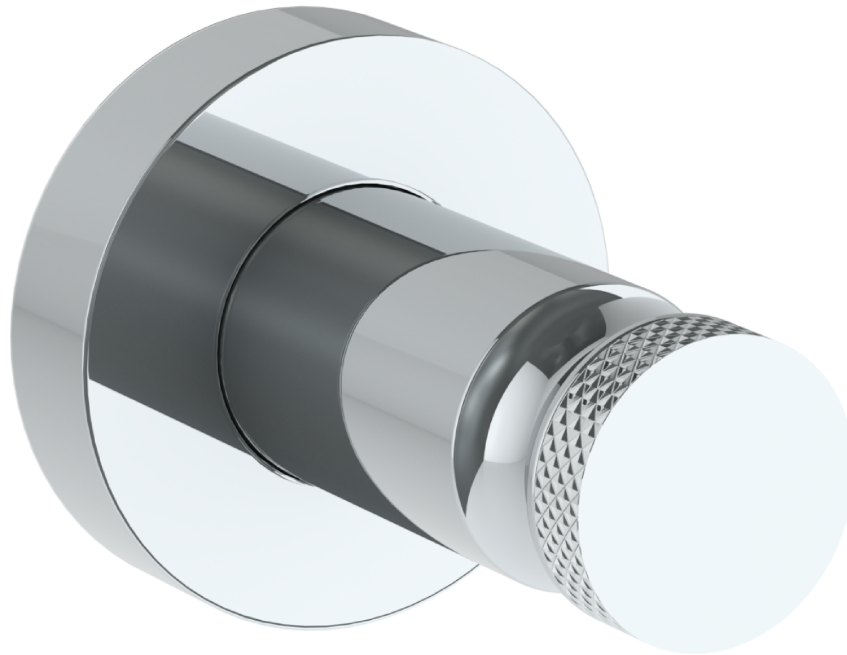

Meets the applicable requirements of ASME A112.18.1-2005/CSA B125.1-05, entitled "Plumbing Supply Fittings"